

IP67防水数显可换测头深度尺

←INSIZE→PLUS

防油塑料罩壳和按键

IP67
防尘防水

数据
传输



1441-300

双钩测头(标配)

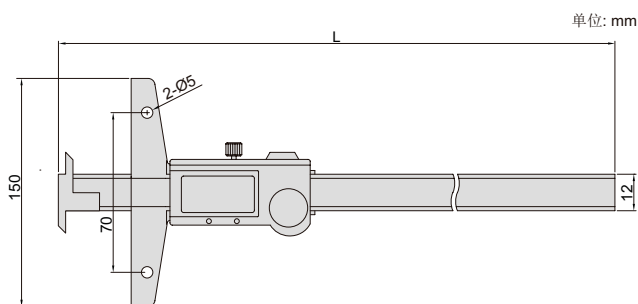
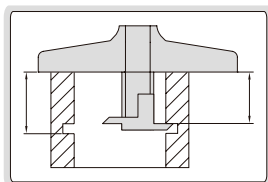
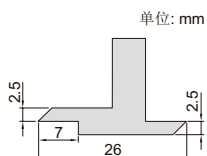

单位: mm

- 符合GB/T深度卡尺国家标准
- 防尘/防水等级: IP67
- 分辨率: 0.01mm/0.0005"
- 按键: 置零, 公/英制转换, 设置初始值
- CR2032电池, 自动关机
- 自动关机后, 可拉动尺身开机
- 数据传输
- 不锈钢尺身
- 可安装加长底座
- 可选附件: 测头(型号1441-P1, 1441-P2, 1441-P3), 数据传输线(型号7302-80, 7315-80), 加长底座(6141系列)

加长底座(选配)



6141系列

型号	测量范围	精度	L
1441-300	0-300mm/0-12"	±0.03mm	410mm
1441-400	0-400mm/0-16"	±0.04mm	510mm
1441-500	0-500mm/0-20"	±0.05mm	610mm
1441-600	0-600mm/0-24"	±0.05mm	710mm

侧向球测头(选配)

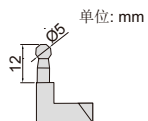

单位: mm

型号
1441-P1

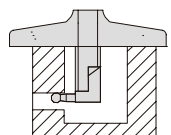

球测头(选配)

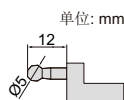

单位: mm

型号
1441-P2

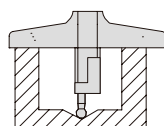

针测头(选配)

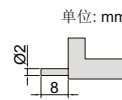

单位: mm

型号
1441-P3

